

PR-216 OPERATOR'S MANUAL

PR-216

High Performance Personal Receiver

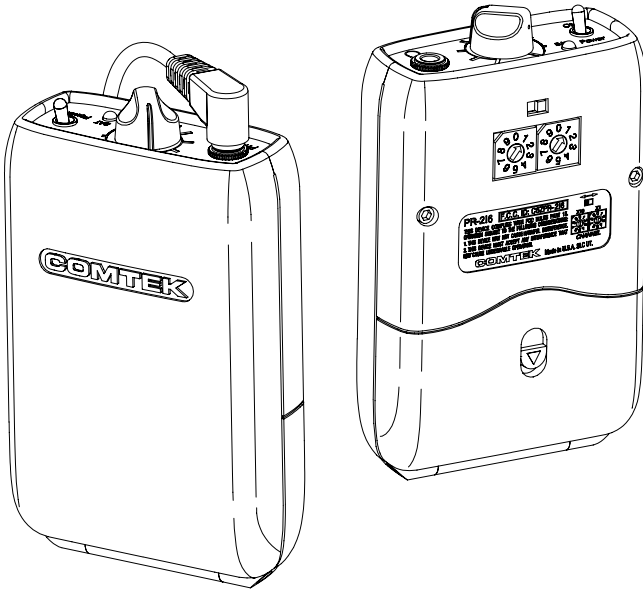

COMTEK®

TABLE OF CONTENTS

Introduction	1
Controls	2
Setup	3
Frequency Selection	4
Multiple Channel Operation	4
Frequency Groups	5
Frequency Chart	6
Monitoring Capabilities	7
Low Battery Indicator	8
Battery Removal and Replacement	8
Battery Charging	9
Belt Clip Installation and Removal	10
Optional Accessories	11
Specifications	12
Warranty and Service	13

INTRODUCTION

PR-216

High Performance Personal Receiver

The PR-216 is a professional quality, personal monitor receiver designed to operate with transmitters in the 216-217 MHz band under Part 95 of the FCC regulations. This versatile receiver can tune both standard and high-fidelity channels for a variety of speciality applications: assistive listening, personal cueing, language interpretation, tour guide monitoring, and other personal remote monitoring applications.

The PR-216 receiver incorporates both advanced digital and analog micro-circuit technologies to produce superior audio performance with the convenience of channel-selectability to accommodate adverse multi-channel operation.



PR-216 CONTROLS

❶ AUDIO OUTPUT JACK: This stereo 3.5 mm audio output jack accommodates any low impedance headphone — either stereo or mono; also, charging input for rechargeable battery, and auxiliary power input.

❷ VOLUME CONTROL: This control has 50 dB of range to adjust the audio output for a comfortable listening level (clockwise for maximum level).

❸ POWER / RECEIVER STATUS INDICATOR:

The LED test indicator displays three functions:

1. The indicator will illuminate continuously when unit is “ON” and NO signal is being received.
2. A steady slow flash indicates the receiver is receiving a signal on the tuned channel.
3. A rapid flash of the LED indicator and a subtle beeping signal indicates a low battery.

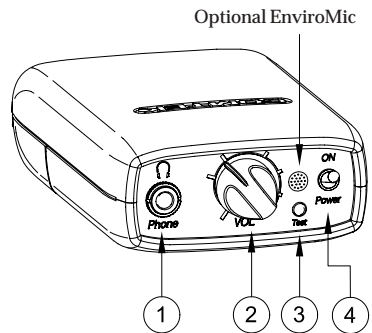

❹ ON / OFF SWITCH: This switch turns the receiver on and off.

❺ EnviroMic ON / OFF: This switch turns optional EnviroMic on or off.

Note: If receiver does not have EnviroMic option, this switch is non-operational.

❻ CHANNEL SWITCHES:

These rotary switches select the channel. Channel must be the same as transmitter’s channel. (See page 6 for frequency selection chart.)

❼ BATTERY COMPARTMENT: The battery compartment features a hinged battery cover and an alignment system that ensures proper battery polarity. Battery installation and removal is facilitated by simply manipulating the rear of the battery.

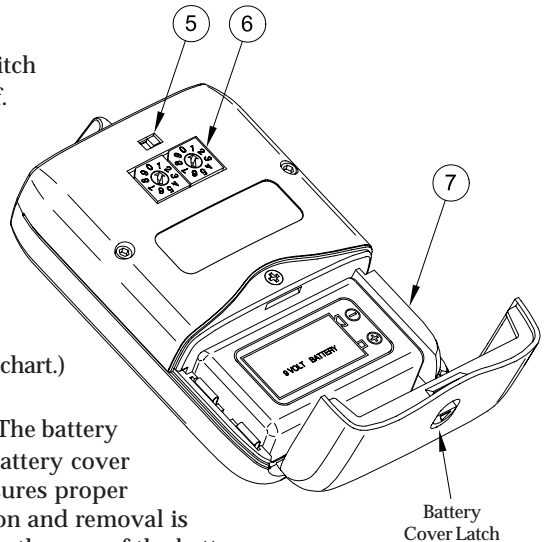

PR-216 OPERATING INSTRUCTIONS

Setup

a. Check to ensure that the PR-216 receiver's radio frequency channel is the same as the associated COMTEK transmitter's channel.

(Channels are indicated by the rotary switches on the back of the receiver. See page 4.)

b. Open the battery cover on the receiver (see page 8) and insert a new nine volt alkaline battery (Eveready E522 or equivalent). This type of battery will offer up to 30 hours of operation. *(Replace the battery before every use if the demand for fail-safe operation outweighs battery cost. The use of carbon batteries is not recommended.)*

NOTE: If a rechargeable battery is to be used, ensure that the battery has a full charge before use (see page 9 for battery charger instructions).

c. Connect the headphone to the receiver by inserting the headphone plug into the receptacle on the top of the receiver. The receiver is operating when the receiver power switch is turned on and the battery status on indicator illuminates.

NOTE: The headphone cord also functions as part of the receiver's antenna system. For optimum performance, this cord should be fully extended. Coiling or bunching the headphone cord may reduce the range of the receiver. Also, coil-cord type headphone cords are *not* recommended. The receiver should be carried by the snap-on belt clip (included) or in a pocket or belt-clip pouch.

d. Set the audio output level control to a comfortable listening volume. This control is turned clockwise for maximum output level.

PR-216 OPERATING INSTRUCTIONS

Frequency Selection (216-217 MHz)

The PR-216 personal receiver can operate on one of 76 available channels between 216 MHz and 217 MHz. COMTEK's channel designations indicate both standard narrow-band channels and high-fidelity, wide-band companded channels. Channels 1-40 are narrow-band channels (5 kHz deviation) offering compatibility with other manufacturers' receivers such as the Phonak MicroEar. Channels 41-60 are high-fidelity, wide-band companded channels (10 kHz deviation) for use with COMTEK transmitters. Channels 61-79 are standard narrow-band channels for compatibility with other manufacturers. COMTEK transmitters automatically transmit the proper modulation when set to channels 1-40 for narrow-band or 41-60 for wide-band companded channels.

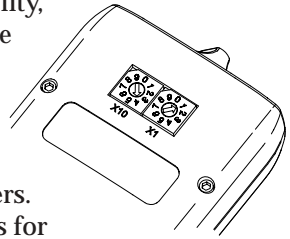

After you have determined the channel on which you are going to operate, position the two rotary switches to indicate the channel. The left rotary switch is for *tens* and the right rotary switch is for *ones*. To select channel 41 (216.0250 MHz), position the left rotary switch to point to 4 (X10), and position the right rotary switch to point to 1 (X1). *Refer to frequency charts on pages 5 and 6 for selectable frequencies.*

Multiple Channel Operation

Simultaneous operation with more than two channels requires frequency coordination to avoid intermodulation interference. This interference could result in poor or unusable performance. When multiple transmitters are broadcasting, the RF signals will “mix” together generating additional signals. If these product frequencies are too close to a frequency which you are using, you will experience this type of interference. This condition is common to all radio receivers to some extent. This interference produces whistle and whine type sounds and/or reductions of range. **To avoid this type of interference, you should select frequencies from one of the standard groups (see frequency group charts on page 5), or you can use COMTEK's frequency selection guide software to determine appropriate frequencies.** Contact COMTEK to obtain a free copy of the frequency selection software or download it off the web at www.comtek.com/software.htm.



PR-216

216 MHz NARROW-BAND FREQUENCY GROUPS

Compatible with COMTEK
and other manufacturers
(5 kHz deviation)

GROUP A

CHANNEL	FREQUENCY
1	216.0125 MHz
9	216.2125 MHz
15	216.3625 MHz
24	216.5875 MHz
31	216.7625 MHz
36	216.8875 MHz

GROUP B

CHANNEL	FREQUENCY
4	216.0875 MHz
10	216.2375 MHz
14	216.3375 MHz
32	216.6875 MHz
35	216.8875 MHz
40	216.9875 MHz

GROUP C

CHANNEL	FREQUENCY
3	216.0624 MHz
5	216.1125 MHz
12	216.2875 MHz
22	216.5375 MHz
38	216.9375 MHz

GROUP D

CHANNEL	FREQUENCY
17	216.4125 MHz
23	216.5625 MHz
30	216.7375 MHz
34	216.8375 MHz
39	216.9625 MHz

PR-216

216 MHz WIDE-BAND FREQUENCY GROUPS

For COMTEK
equipment only
(10 kHz deviation)

GROUP 1

CHANNEL	FREQUENCY
41	216.0250 MHz
44	216.1750 MHz
51	216.5250 MHz
55	216.7250 MHz
60	216.9750 MHz

GROUP 2

CHANNEL	FREQUENCY
42	216.0750 MHz
49	216.4250 MHz
53	216.6250 MHz
58	216.8750 MHz

GROUP 3

CHANNEL	FREQUENCY
43	216.1250 MHz
46	216.2750 MHz
51	216.5250 MHz
57	216.8250 MHz

GROUP 4

CHANNEL	FREQUENCY
44	216.1750 MHz
47	216.3250 MHz
54	216.6750 MHz
59	216.9250 MHz

PR-216 FREQUENCY CHART (216-217 MHz band)

Narrow-Band Channels; 5 kHz dev.
 For use with COMTEK and other manufacturers
 (Educational Standard)

CHANNEL (SWITCH POSITION)	FREQUENCY
01	216.0125 MHz
02	216.0375 MHz
03	216.0625 MHz
04	216.0875 MHz
05	216.1125 MHz
06	216.1375 MHz
07	216.1625 MHz
08	216.1875 MHz
09	216.2125 MHz
10	216.2375 MHz
11	216.2625 MHz
12	216.2875 MHz
13	216.3125 MHz
14	216.3375 MHz
15	216.3625 MHz
16	216.3875 MHz
17	216.4125 MHz
18	216.4375 MHz
21	216.5125 MHz
22	216.5375 MHz
23	216.5625 MHz
24	216.5875 MHz
25	216.6125 MHz
26	216.6375 MHz
27	216.6625 MHz
28	216.6875 MHz
29	216.7125 MHz
30	216.7375 MHz
31	216.7625 MHz
32	216.7875 MHz
33	216.8125 MHz
34	216.8375 MHz
35	216.8625 MHz
36	216.8875 MHz
37	216.9125 MHz
38	216.9375 MHz
39	216.9625 MHz
40	216.9875 MHz

High-Fidelity Channels; 10 kHz dev.
 For use with COMTEK equipment only
 (Companded)

CHANNEL (SWITCH POSITION)	FREQUENCY
41	216.0250 MHz
42	216.0750 MHz
43	216.1250 MHz
44	216.1750 MHz
45	216.2250 MHz
46	216.2750 MHz
47	216.3250 MHz
48	216.3750 MHz
49	216.4250 MHz
51	216.5250 MHz
52	216.5750 MHz
53	216.6250 MHz
54	216.6750 MHz
55	216.7250 MHz
56	216.7750 MHz
57	216.8250 MHz
58	216.8750 MHz
59	216.9250 MHz
60	216.9750 MHz
61	216.0250 MHz
62	216.0750 MHz
63	216.1250 MHz
64	216.1750 MHz
65	216.2250 MHz
66	216.2750 MHz
67	216.3250 MHz
68	216.3750 MHz
69	216.4250 MHz
71	216.5250 MHz
72	216.5750 MHz
73	216.6250 MHz
74	216.6750 MHz
75	216.7250 MHz
76	216.7750 MHz
77	216.8250 MHz
78	216.8750 MHz
79	216.9250 MHz
70	216.9750 MHz

PR-216 OPERATING INSTRUCTIONS

Monitoring Capabilities

Because each monitoring application requires a different headphone or transducer to best satisfy each listening need, the PR-216 can source a strong audio signal (+16 dBu) to either stereo or mono headphones with an impedance as low as 16 ohm. A hearing-aid type button receiver may be used with impedances as high as 2 k ohm and still produce a strong audio signal.

The PR-216 is ideal for use with the COMTEK NTC-102 neckloop transducer and wireless IR-230 miniature universal-fit ear canal inductor receiver or hearing aids having a "T" switch.

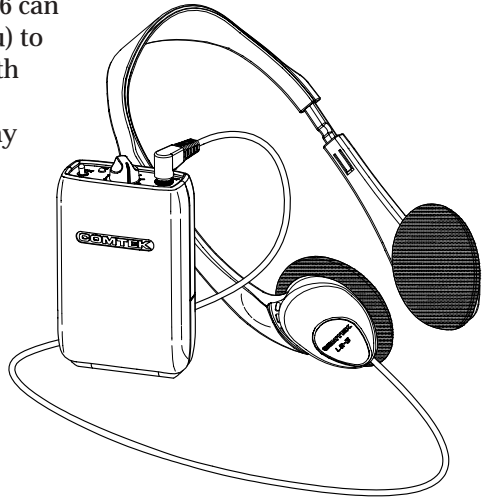

Can be used with consumer or professional headphones.

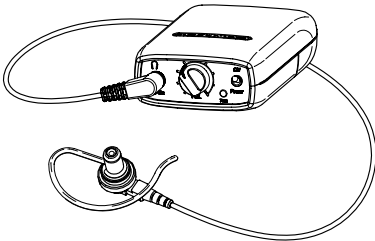

Can be used with hearing aid button receiver for assistive listening or acoustic ear tube for IFB application.

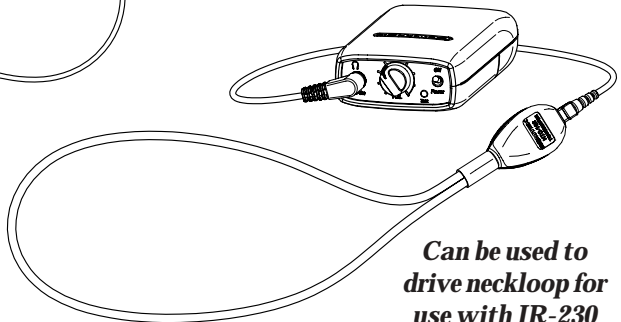

Can be used to drive neckloop for use with IR-230 inductor receiver or hearing aids.

PR-216 OPERATING INSTRUCTIONS

Low Battery Indicator

The LED on the receiver is a multi-function indicator which includes low battery detection. When the receiver is first turned on, the indicator will illuminate continuously indicating that the unit is “ON” and NO signal is being received. When the receiver is receiving a signal on the tuned channel, the LED will show a steady slow flash indicating reception. A rapid flash on the LED indicator and a subtle beeping signal through the headphone indicates a low battery. Replace battery as soon as possible with a new alkaline battery or charge the rechargeable battery, as performance of the receiver will be unpredictable and may vary from audio distortion to complete failure to operate.

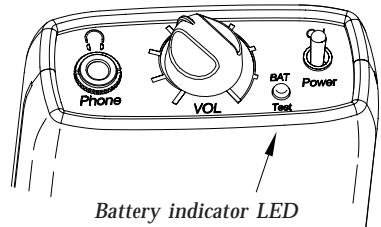

Battery Removal / Replacement

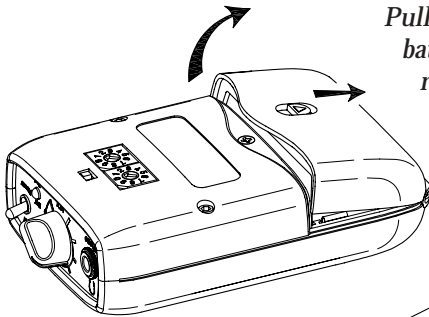

Pull back battery door latch and allow battery cover door to spring open. To remove battery, simply manipulate the bottom of battery out of the compartment and remove.

To insert battery, face battery with negative terminal in line with large hole in battery compartment, press battery into compartment and close battery door until it snaps shut. Note: It is not possible to put battery in backwards.

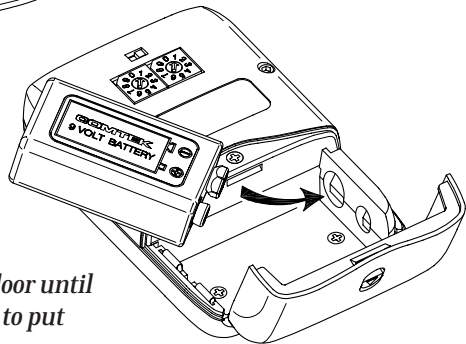

PR-216 OPERATING INSTRUCTIONS

Battery Charging

1. Make sure that a seven cell 9 volt Ni-MH rechargeable battery is used with a minimum of 150 mAh capacity. **(Alkaline batteries must not be charged.)**
2. Make sure the PR-216 is turned **OFF**.
3. Note that the red charging indicator on the charger is **ON** when the PR-216 is plugged into the charger through the audio output jack.
4. When using the NBC 9-2C charger allow the battery to charge for 12 hours for a full charge. Unit must then be unplugged. When using the NBC 9-3-1 digital fast charger the charger will automatically end the charge cycle and the red LED will change to green. With this charger the unit may be left in the charger until the unit is used.
5. Periodically open the battery compartment on stored COMTEK units to check for battery leakage. If a battery is leaking, it must be discarded, and the battery compartment must be cleaned or returned to COMTEK's service department for repairs.

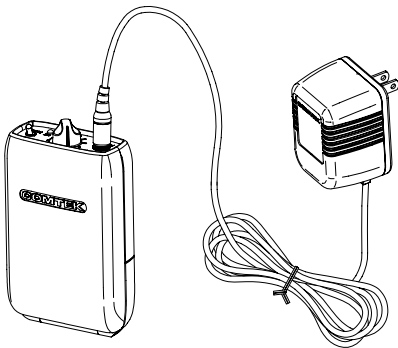

NBC 9-2C
12 hour charger

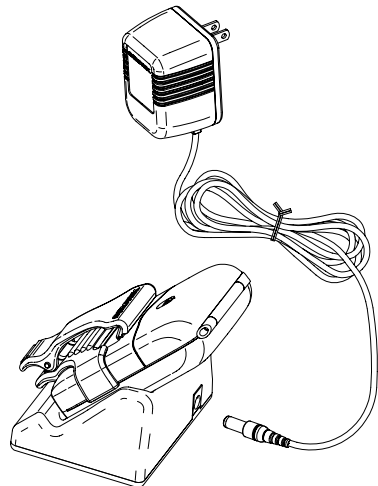

NBC 9-3-1
digital fast charger

PR-216 SNAP ON BELT CLIP

Belt clip installation

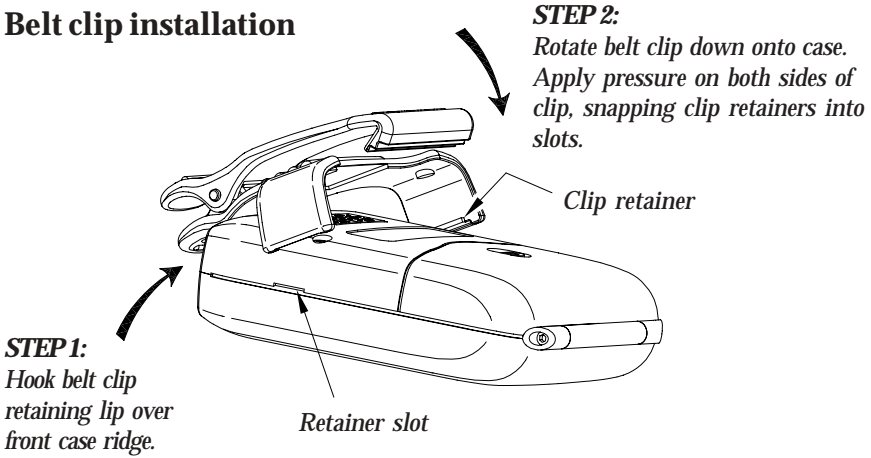

Belt clip removal

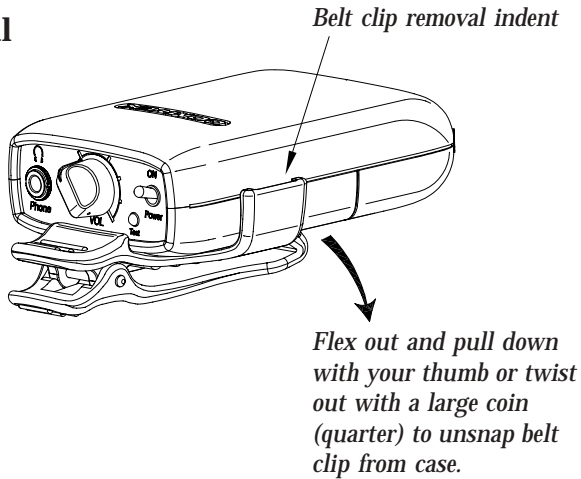

PR-216 OPTIONAL ACCESSORIES

Optional Accessories

1. NBC 9-2C Dual 12 hour 9V only battery charger
2. NH9-150 Rechargeable Ni-MH battery
3. P1 Universal pouch
4. BC-216 Snap-on belt clip
(supplied with PR-216)
5. ET-4 SM-N Button receiver with acoustic ear tube
6. LS-3 High efficiency headphones
7. SM-N Button receiver earphone assembly
8. NTC-102 Neckloop transducer
(for use with inductor receiver IR230)
9. NBC 9-3-1 Digital single fast charger
10. NBC 9-3-12 Digital 12 station fast charger

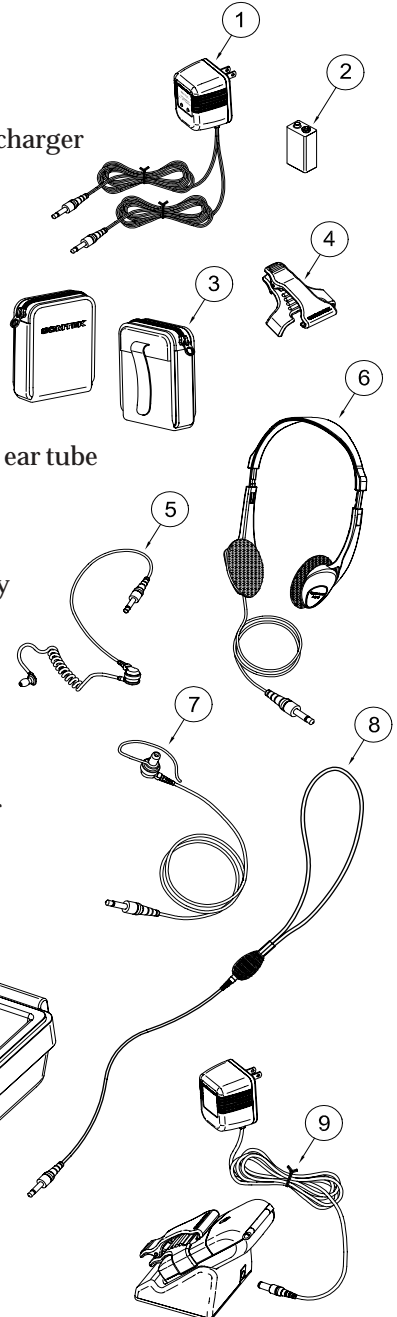

PR-216 SPECIFICATIONS

Audio Output:

Headset output +16 dBu
(low impedance)

Connector:

3.5 mm stereo/mono input used for:

- Headphone cord antenna to receiver
- Audio output to headphone
- Battery charger input
- Auxiliary power input

Indicators:

Three function LED

- Power
- Battery status
- R.F. signal ON and OFF

Controls:

- Power On/Off switch
- Volume control (50 dB range)
- EnviroMic ON/OFF switch (optional)
- 99 position rotary channel selector switches

Audio Frequency Response:

80 Hz to 12 kHz ± 3 dB

Harmonic Distortion:

Less than 1% (1 kHz tone 5 kHz deviation)

Operating Radio Frequency:

- 216 to 217 MHz
- Frequency synthesized

Frequency Stability:

0.002% frequency synthesized
crystal controlled

RF Sensitivity:

0.3 μ V for 12 dB SINAD

Adjacent Channel Rejection:

65 dB 50 kHz off channel

Spurious Rejection:

60 dB (image excluded)

Ultimate Quieting:

Better than 95 dB

Deviation Acceptance:

Up to 10 kHz

Antenna:

Integral with output cable
(no external antenna)

Current Drain:

15 mA nominal

Power Requirements:

9 volt alkaline battery,
Eveready 522 or equivalent
or 9 volt Ni-MH rechargeable

FCC Compliance:

Complies with Part 15
of FCC rules

Dimensions:

1 $\frac{1}{16}$ " x 2 $\frac{1}{2}$ " x 3 $\frac{1}{4}$ "
(27 mm x 57 mm x 83 mm)

NOTE: Specifications subject to
change without notice

PR-216 WARRANTY AND SERVICE

Warranty

COMTEK warrants this product to be free from defects in workmanship and material under normal use and conditions for a period of one year from date of original purchase. Items such as batteries, neckloops, and cords are not covered by the warranty. Damage due to misuse, ill treatment and unauthorized modification and repairs are not covered by this warranty. COMTEK is not liable for consequential damages arising out of any failure of the equipment to perform as intended. COMTEK shall bear no responsibility or obligation with respect to the manner of use of any equipment sold by it. COMTEK SPECIFICALLY DISCLAIMS AND NEGATES ANY WARRANTY OF MERCHANTABILITY OR FITNESS FOR A PARTICULAR PURPOSE OF SUCH EQUIPMENT INCLUDING, WITHOUT LIMITATION, ANY WARRANTY THAT THE USE OF SUCH EQUIPMENT FOR ANY PURPOSE WILL COMPLY WITH APPLICABLE LAWS AND REGULATIONS.

Service Policies

Warranty repairs must be done by COMTEK. Only factory technicians are authorized to perform warranty service on the PR-216 receiver. Before returning the PR-216 for service, a Return Authorization Number should be obtained from the service department by calling 1-800-496-3463 or 1-801-466-3463. Return the unit to the factory with the original or comparable packaging. COMTEK will pay for insurance and ground return shipping costs in the United States for all warranty service.

COMTEK®

First Quality in Wireless Sound

357 West 2700 South • Salt Lake City, Utah 84115
Phone: (800) 496-3463 • Fax: (801) 484-6906
Web Page: <http://www.comtek.com>